



## BERG BUZZY 2<sup>IN</sup>1

Product sheet XL



BUZZY NITRO 2-in-1, BUZZY BLOOM 2-in-1

*More stable, faster  
and more **fun and games**  
than on any tricycle!*

years

**2.5**

85 to 115 cm

**BERGTOYS.COM**



## BERG BUZZY 2<sup>IN</sup>1

Beats every tricycle - due to 4 wheel stability

The BERG Buzzy is now also available as a BERG Buzzy 2-in-1. This stable go-kart can now also be used as a push car, so you can take your child with you safely and easily when you go out. The push bar helps you keep control of the go-kart and your child when you are in a hurry. The stability of the Buzzy keeps it safely grounded at all times, even with very active children or when riding over bumpy surfaces. This is in stark contrast to the many 2-in-1 tricycles which are much less stable.

The Buzzy 2-in-1 is, of course, also just a Buzzy. The four wheels ensure stability. The Buzzy is easy to steer because the pedals are not connected to the handlebars, and easy to ride because the handlebars are not pushed away from the child's hands when pedalling.

Is your child tired and wanting to be pushed or perhaps full of energy and wanting to play? In that case the Buzzy can be converted from a push car to a go-kart or from a go-kart to a push car in the wink of an eye.



**BUZZY**  
**BEATS EVERY**  
**TRICYCLE**  
DUE TO 4 WHEEL STABILITY

1. activate freewheel

2. activate steering lock

3. attach push bar

4. set correct height



More stable, faster  
and more **fun and games**  
than on any tricycle!







## SWITCHABLE FREEWHEEL

The Buzzy 2-in-1 can be used in 2 modes thanks to the switchable freewheel. The pedal mode enables your child to ride around independently just like on a normal Buzzy. In the push mode the pedals are inactive and the Buzzy can be pushed without the pedals turning. Switching between the two modes is easy by simply turning the ring around the crank axle to the left or the right.

pedal mode:

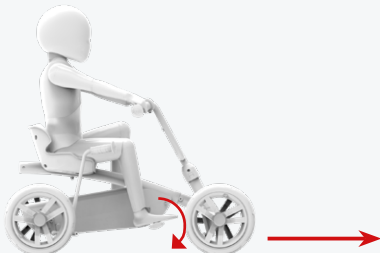

The pedals provide propulsion so that you can move forward independently

push (freewheel) mode:

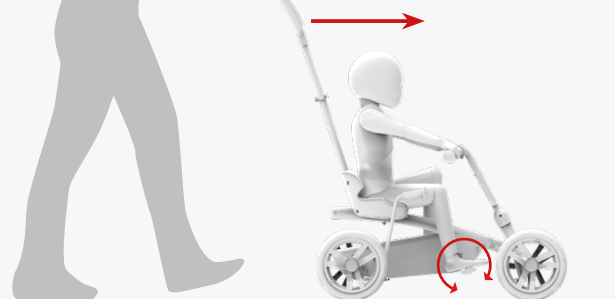

The pedals can still be moved but they no longer propel the go-kart. The freewheel mode makes it easy to push the Buzzy with the push bar.

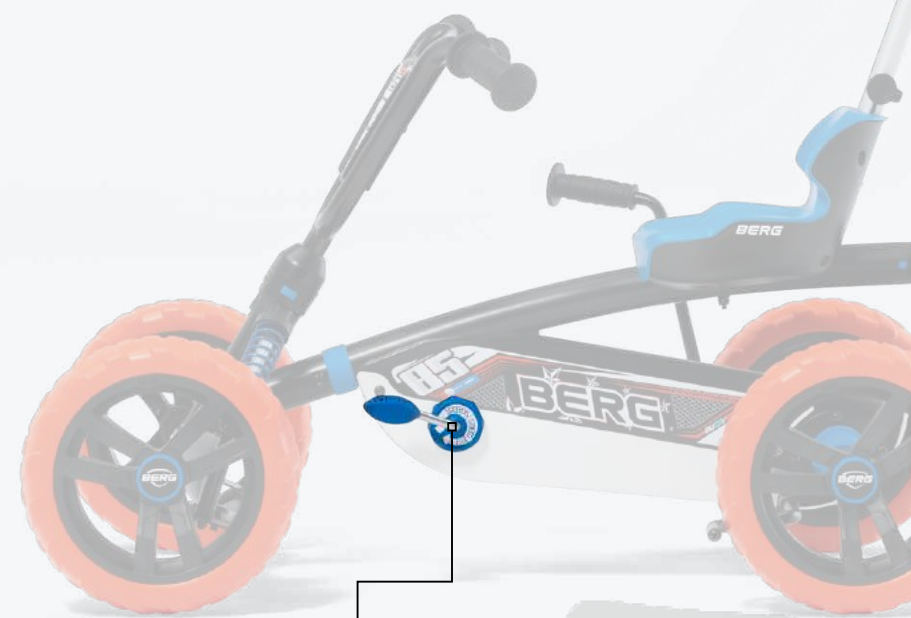

Simply turn the ring to the right to switch from pedal mode to freewheel mode to push the Buzzy 2-in-1.



*More stable, faster  
and more **fun and games**  
than on any tricycle!*





## USER-FRIENDLY STEERING LOCK

The Buzzy 2-in-1 is equipped with a user-friendly steering lock to help you walk safely and easily with it. When the steering lock is in operation your child can no longer steer and the parent is in control regardless of the situation. The steering lock is easy to switch on and off by pushing the operating pin on the steering head from one side to the other.

When the steering lock is switched on the Buzzy 2-in-1 can easily be steered by tilting the front wheels up slightly and pushing the Buzzy 2-in-1 in the right direction.

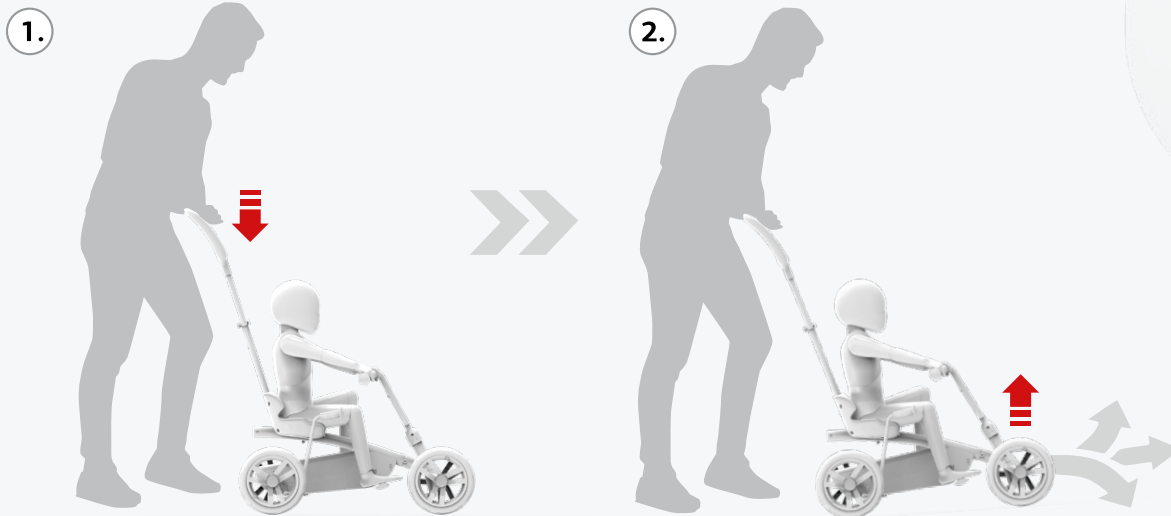
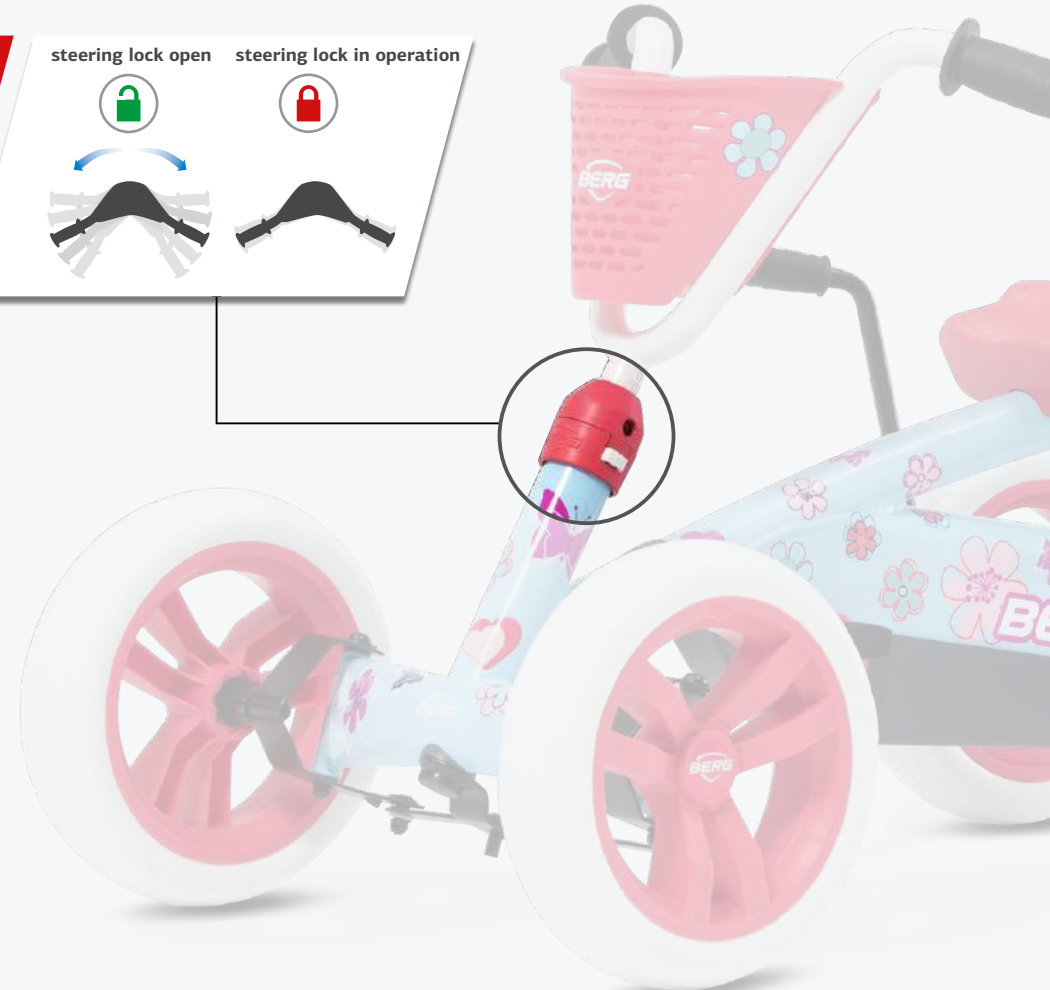
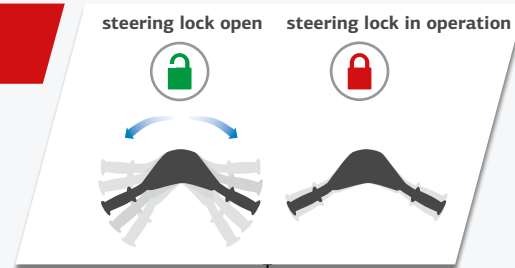

More stable, faster  
and more **fun and games**  
than on any tricycle!





## ADJUSTABLE PUSH BAR

The push bar can easily be adjusted to 3 heights. The Buzzy 2-in-1 can be pushed easily from A to B in combination with the comfortable handle. When your child wants to ride the Buzzy without being pushed, the push bar can be removed in a jiffy. The Buzzy 2-in-1 is then transformed from a safe, stable push car into a supercool and stable go-kart.

The push bar is easy to adjust in height and easy to attach or remove



More stable, faster  
and more **fun and games**  
than on any tricycle!





## CONTROLLED STEERING AND PEDALLING

Unlike a tricycle, the pedals and the handlebars of the Buzzy can be operated independently. This ensures that the pedals do not move when steering and the feet remain firmly on the pedals at all times. Riding and steering therefore have no influence on each other, which makes riding on the Buzzy much more fun.

**TRICYCLE**

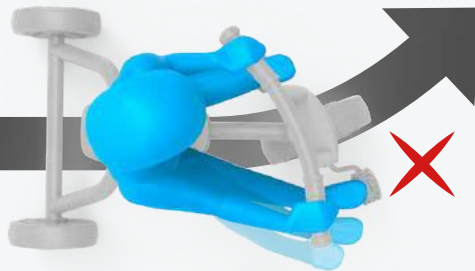

**BUZZY**  
**BEATS EVERY**  
**TRICYCLE**

*DUE TO 4 WHEEL STABILITY*



*More stable, faster  
and more **fun and games**  
than on any tricycle!*







## SMOOTH AND FAST ACCELERATION

Because the pedals and the handlebars on a tricycle are connected to each other, a lot of energy is lost in the motion of the handlebars when setting off. The pedals and the handlebars on a Buzzy are not connected and therefore the energy used when pedalling is directly converted into the forward movement of the Buzzy.

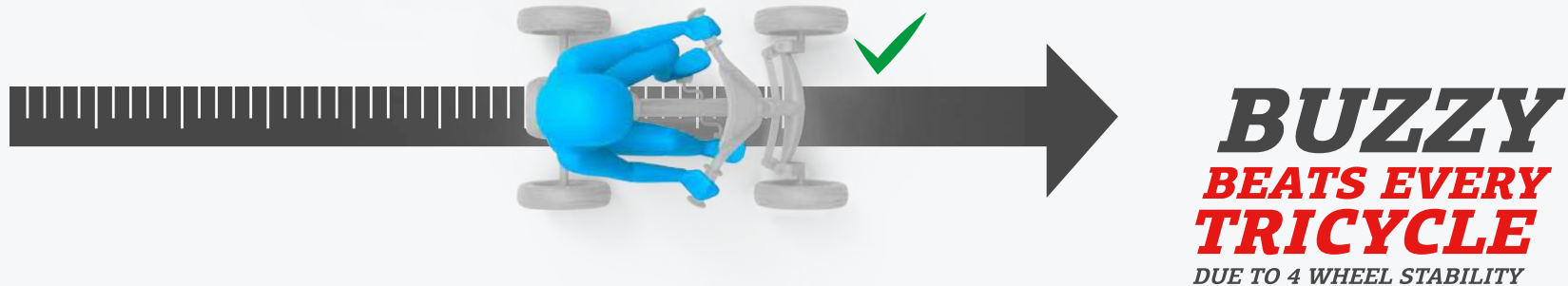

Place a tricycle next to a Buzzy and you will see how easy and smooth the Buzzy sets off.

*More stable, faster  
and more **fun and games**  
than on any tricycle!*





## HANDBRAKE & EVA TYRES

The Buzzy 2-in-1 is equipped with a handbrake for extra safety. Apply the handbrake and the Buzzy comes to a rapid standstill.

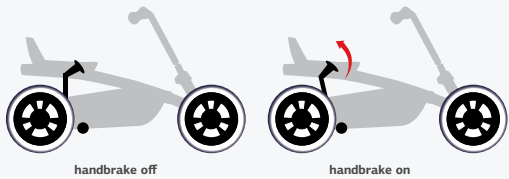

An EVA tyre is made from high-tech foam. High-tech foam is the ideal replacement for the traditional rubber inner and outer tyres of the BERG BUZZY. Thanks to the right composition, the tyres are just as wear-resistant as traditional rubber tyres but without the risk of a flat tyre.



*The tyres are very silent when riding around, which makes them ideal for indoor and outdoor use on different types of surfaces.*



*More stable, faster  
and more **fun and games**  
than on any tricycle!*







# CHARACTERISTICS

**BEATS EVERY TRICYCLE**  
DUE TO 4 WHEEL STABILITY

suitable for children from 2 to 5 years old  
also available in the Nitro version

the pedals remain within easy reach when steering

handbrake for extra safety

built-in steering lock / can be activated without tools

can be ridden forwards and backwards

the swing axle provides perfect roadholding

comfortable handle

lightweight aluminium tube, easy to attach or remove

adjustable push bar (3 heights)

comfortable and adjustable seat with extra back support

four wheels for better stability and safety

EVA tyres, so no more flat tyres

switchable freewheel

direct drive system makes pedalling intuitive & easy



The Buzzy 2-in-1 is exclusively available as Buzzy Bloom 2-in-1 and as Buzzy Nitro 2in1.

*More stable, faster and more **fun and games** than on any tricycle!*





24.32.00.00

## BERG BUZZY NITRO 2<sup>IN</sup>1

Beats every tricycle - due to 4 wheel stability

Do you want a cool off-road go-kart for your child and a safe, stable push car that you can take with you on walks with your child? The BERG Buzzy Nitro 2-in-1 combines both in one product. The cool stickers, excellent suspension and, of course, the fantastic tyres make this off-road monster the coolest go-kart in the neighbourhood.



Product weight: 8.0 kg  
Weight plus box: 9.5 kg  
Size of box (cm): 46x50x25



**BERGTOYS.COM**

EAN CODE: **8715839068320**





24.32.00.01

## BERG BUZZY BLOOM 2<sup>IN</sup>1

Beats every tricycle - due to 4 wheel stability

Do you want a cheerful and playful go-kart for your child with a handy storage basket and a safe, stable push car that you can take with you on walks with your child? The BERG Buzzy Nitro 2-in-1 combines both in one product. The cheerful colours, the handy basket and the flowers that you can stick on yourself make it the best looking go-kart in the neighbourhood!



Product weight: 7.8 kg  
Weight plus box: 9.3 kg  
Size of box (cm): 46x50x25



**BERGTOYS.COM**

EAN CODE: **8715839071719**





## BERG BUZZY DATA

Beats every tricycle - due to 4 wheel stability

The following data applies to all Buzzy 2-in-1 versions.

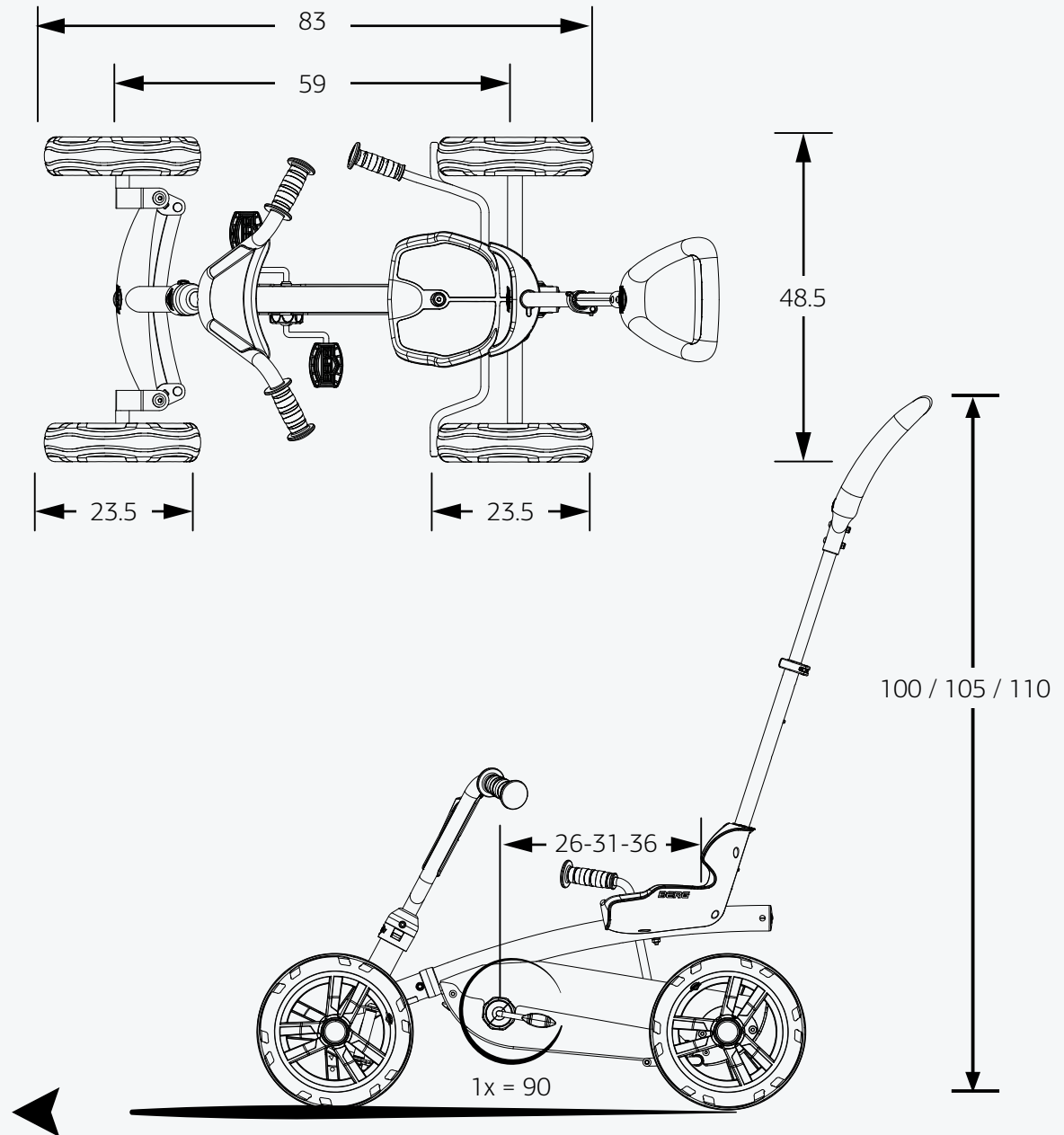
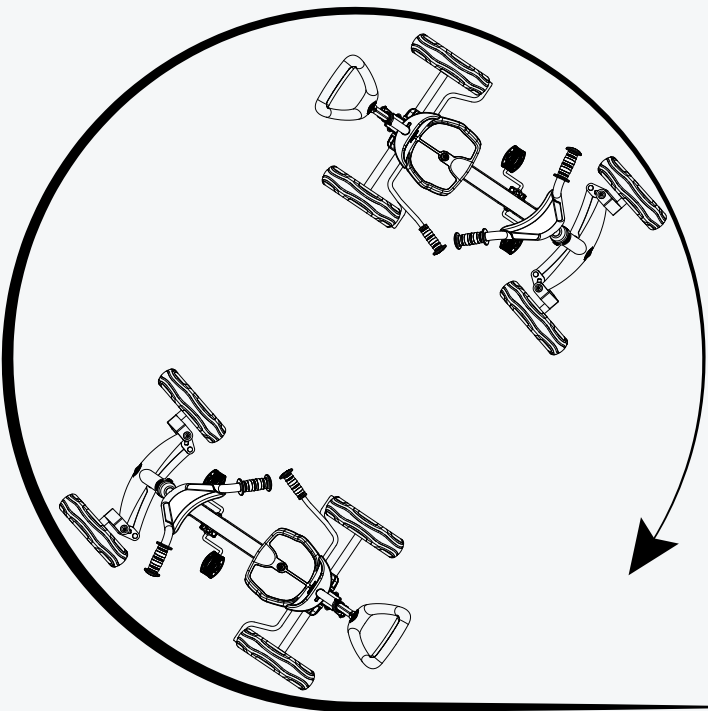
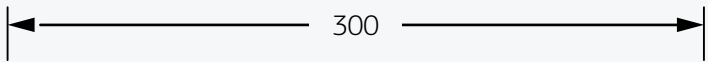

\*All sizes in cm



## BERG BUZZY DATA

Beats every tricycle - due to 4 wheel stability

### General

Recommended age	2 to 5 years
Min user height	85 cm
Max user height	115 cm
Max user weight	30 kg
Parental supervision necessary	Yes
Safety mark	TÜV + CE
Assembly time	±30 min.

### Physical specifications

Length	83 cm
Width	49 cm
Height	50 cm

### Warranty

Frame	2 years
Parts	2 years
Tyres	0 years

### Technical specifications

Gears	N/A
Tyre type	EVA foam
Frame material	Steel
Forwards and backwards	Yes
Braking system	Direct Drive + handbrake
Parking brake	N/A
Transmission	Direct Drive + freewheel
Ball bearings	Yes
Swing axle	Yes
Adjustable seat	Yes
Adjustable steering wheel	No
Trailer connection	No

### Packaging

Dimensions	46x50x25 cm
Cardboard in packaging	1.50 kg
Synthetic material in packaging	0.05 kg
Hardboard in packaging	0 kg
Quantity on Blok pallet	40 pcs
Quantity on Euro pallet	21 pcs

\*This information is subject to change, and may differ



